

# LTC3330

## Energy Harvesting DC/DC with Battery Backup

### FEATURES

- Dual Input, Single Output DC/DC's with Input Prioritizer  
 Energy Harvesting Input: 3.0V to 18V Buck DC/DC  
 Primary Cell Input: 1.8V to 5.5V Buck-Boost DC/DC
- Zero Battery  $I_Q$  When Powering Load from Harvested Energy
- Ultralow Quiescent Current: 900nA at No-Load
- Low Noise LDO Post Regulator
- Integrated Supercapacitor Balancer
- Up to 50mA of Output Current
- Programmable DC/DC and LDO Output Voltages, Buck UVLO, and Buck-Boost Peak Input Current
- Integrated Low Loss Full-Wave Bridge Rectifier
- Input Protective Shunt—Up to 25mA at  $V_{IN} \geq 20V$
- 5mm × 5mm QFN-32 Package

### APPLICATIONS

- Energy Harvesting
- Solar Powered Systems with Primary Cell Backup
- Wireless HVAC Sensors and Security Devices
- Mobile Asset Tracking

### DESCRIPTION

The LTC<sup>®</sup>3330 integrates a high voltage energy harvesting power supply plus a DC/DC converter powered by a primary cell battery to create a single output supply for alternative energy applications. The energy harvesting power supply, consisting of an integrated full-wave bridge rectifier and a high voltage buck converter, harvests energy from piezoelectric, solar, or magnetic sources. The primary cell input powers a buck-boost converter capable of operation down to 1.8V at its input. Either DC/DC converter can deliver energy to a single output. The buck operates when harvested energy is available, reducing the quiescent current draw on the battery to essentially zero. The buck-boost takes over when harvested energy goes away.

A low noise LDO post regulator and a supercapacitor balancer are also integrated, accommodating a wide range of output storage configurations.

Voltage and current settings for both inputs and outputs are programmable via pin-strapped logic inputs.

The LTC3330 is available in a 5mm × 5mm QFN-32 package.

LT, LT, LTC, LTM, Linear Technology and the Linear logo are registered trademarks of Linear Technology Corporation. All other trademarks are the property of their respective owners.

### TYPICAL APPLICATION

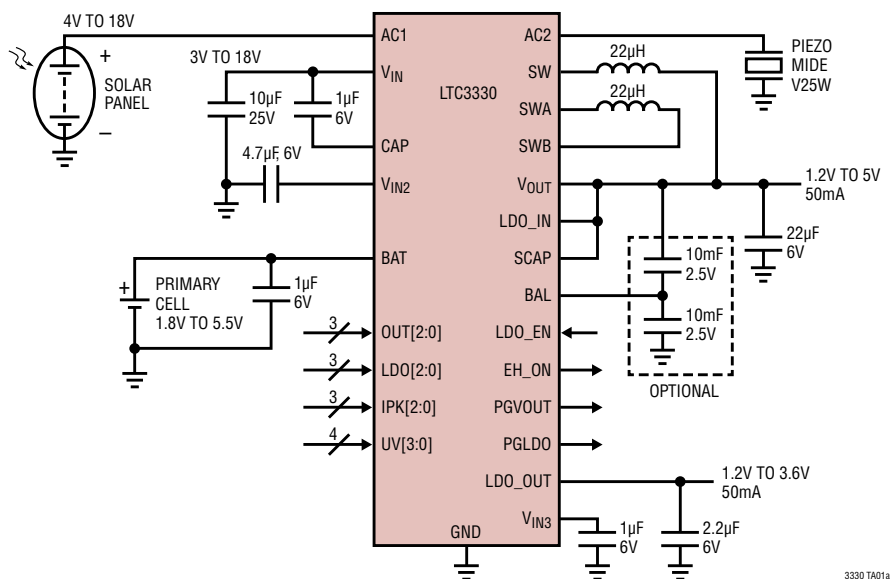

# LTC3330

## ABSOLUTE MAXIMUM RATINGS

(Note 1)

$V_{IN}$	Low Impedance Source .....	-0.3 to 18V*
	Current-Fed, $I_{SW} = 0A$ .....	25mA
AC1, AC2 .....		0 to $V_{IN}$
BAT, $V_{OUT}$ , $V_{IN3}$ , LDO_IN, SCAP, PGMOUT, PGLDO, EH_ON .....		-0.3 to 6V
$V_{IN2}$ .....		-0.3V to [Lesser of ( $V_{IN} + 0.3V$ ) or 6V]
CAP .....		[Higher of -0.3V or ( $V_{IN} - 6V$ )] to $V_{IN}$
LDO_OUT, LDO[2:0], LDO_EN ..		-0.3V to LDO_IN + 0.3V
BAL .....		-0.3V to SCAP + 0.3V
OUT[2:0] .....		-0.3V to [Lesser of ( $V_{IN3} + 0.3V$ ) or 6V]
IPK[2:0] .....		-0.3V to [Lesser of ( $V_{IN3} + 0.3V$ ) or 6V]
UV[3:0] .....		-0.3V to [Lesser of ( $V_{IN2} + 0.3V$ ) or 6V]
$I_{AC1}$ , $I_{AC2}$ .....		$\pm 50mA$
$I_{SW}$ , $I_{SWA}$ , $I_{SWB}$ , $I_{VOUT}$ .....		350mA
$I_{LDO\_OUT}$ .....		50mA
Operating Junction Temperature Range (Notes 2, 3) .....		-40°C to 125°C
Storage Temperature Range .....		-65°C to 125°C

\* $V_{IN}$  has an internal 20V clamp

## PIN CONFIGURATION

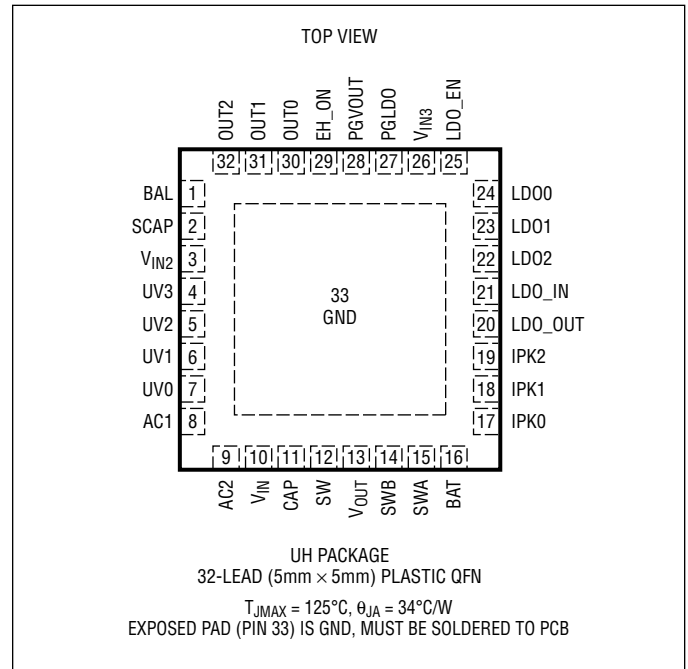

## ORDER INFORMATION

LEAD FREE FINISH	TAPE AND REEL	PART MARKING	PACKAGE DESCRIPTION	TEMPERATURE RANGE
LTC3330EUH#PBF	LTC3330EUH#TRPBF	3330	32-Lead (5mm x 5mm) Plastic QFN	-40°C to 85°C
LTC3330IUH#PBF	LTC3330IUH#TRPBF	3330	32-Lead (5mm x 5mm) Plastic QFN	-40°C to 125°C

Consult LTC Marketing for parts specified with wider operating temperature ranges.

For more information on lead free part marking, go to: <http://www.linear.com/leadfree/>

For more information on tape and reel specifications, go to: <http://www.linear.com/tapeandreeel/>

**ELECTRICAL CHARACTERISTICS** The ● denotes the specifications which apply over the specified operating junction temperature range, otherwise specifications are at  $T_A = 25^\circ\text{C}$  (Note 2).  $V_{IN} = 5\text{V}$ ,  $BAT = 3.6\text{V}$ ,  $SCAP = 0\text{V}$ ,  $LDO\_IN = 0\text{V}$  unless otherwise specified.

SYMBOL	PARAMETER	CONDITIONS	MIN	TYP	MAX	UNITS	
$V_{IN}$	Buck Input Voltage Range	●	3.0		18	V	
$V_{BAT}$	Buck-Boost Input Voltage Range	●	1.8		5.5	V	
$I_{VIN}$	$V_{IN}$ Quiescent Current $V_{IN}$ Input in UVLO Buck Enabled, Sleeping Buck Enabled, Sleeping Buck Enabled, Not Sleeping	$V_{IN} = 2.5\text{V}$ , $BAT = 0\text{V}$ $V_{IN} = 4\text{V}$ , $BAT = 0\text{V}$ $V_{IN} = 18\text{V}$ , $BAT = 0\text{V}$ $V_{IN} = 5\text{V}$ , $BAT = 0\text{V}$ , $I_{SW1} = 0\text{A}$ (Note 4)		450 1150 1650 150	700 1800 2500 250	nA nA nA $\mu\text{A}$	
$I_{BAT}$	BAT Quiescent Current BAT Input with $V_{IN}$ Active Buck-Boost Enabled, Sleeping Buck-Boost Enabled, Not Sleeping	$BAT = 1.8\text{V}$ , $V_{IN} = 5\text{V}$ $BAT = 5\text{V}$ , $V_{IN} = 0\text{V}$ $BAT = 5\text{V}$ , $V_{IN} = 0\text{V}$ , $I_{SWA} = I_{SWB} = 0\text{A}$ (Note 4)		900 200	10 1500 330	nA nA $\mu\text{A}$	
$V_{LDO\_IN}$	LDO_IN Input Range	●	1.8V		5.5V		
$I_{LDO\_IN}$	LDO_IN Quiescent Current	LDO_IN = 5.0V, $I_{LDO\_OUT} = 0\text{A}$		400	600	nA	
$I_{LDO\_OUT}$	LDO_OUT Leakage Current	LDO_IN = 5.0V, LDO_OUT = 5.0V		125		nA	
LDO_OUT	Regulated LDO Output Voltage	Error as a Percentage of Target	●	-2.0	2.0	%	
	LDO Line Regulation (1.8V to 5.5V)	LDO_OUT = 1.2V, 10mA Load		2		mV/V	
	LDO Load Regulation (10 $\mu\text{A}$ to 10mA)	LDO_IN = 5.0V, LDO_OUT = 3.3V		2		mV/mA	
	LDO Dropout Voltage	LDO_OUT = 3.3V, 10mA LOAD		90		mV	
	LDO Current Limit	LDO_IN = 5.0V		50		mA	
$I_{VOUT}$	$V_{OUT}$ Leakage Current	$V_{OUT} = 5.0\text{V}$		125		nA	
$I_{SCAP}$	Supercapacitor Balancer Quiescent Current	SCAP = 5.0V		165	250	nA	
$I_{SOURCE}$	Supercapacitor Balancer Source Current	SCAP = 5.0V, BAL = 2.4V		10		mA	
$I_{SINK}$	Supercapacitor Balancer Sink Current	SCAP = 5.0V, BAL = 2.6V		10		mA	
$V_{BAL}$	Supercapacitor Balance Point	Percentage of SCAP Voltage	●	49	50	51	%
$V_{INUVLO}$	$V_{IN}$ Undervoltage Lockout Thresholds (Rising or Falling)	3V Level	●	2.85	3.00	3.15	V
		4V Level	●	3.80	4.00	4.20	V
		5V Level	●	4.75	5.00	5.25	V
		6V Level	●	5.70	6.00	6.30	V
		7V Level	●	6.65	7.00	7.35	V
		8V Level	●	7.60	8.00	8.40	V
		9V Level	●	8.55	9.00	9.45	V
		10V Level	●	9.50	10.0	10.5	V
		11V Level	●	10.4	11.0	11.6	V
		12V Level	●	11.4	12.0	12.6	V
		13V Level	●	12.3	13.0	13.7	V
		14V Level	●	13.3	14.0	14.7	V
		15V Level	●	14.2	15.0	15.8	V
		16V Level	●	15.2	16.0	16.8	V
		17V Level	●	16.1	17.0	17.9	V
		18V Level	●	17.1	18.0	18.9	V
$V_{SHUNT}$	$V_{IN}$ Shunt Regulator Voltage	$I_{VIN} = 1\text{mA}$		19.0	20.0	21.0	V

**ELECTRICAL CHARACTERISTICS** The ● denotes the specifications which apply over the specified operating junction temperature range, otherwise specifications are at  $T_A = 25^\circ\text{C}$  (Note 2).  $V_{IN} = 5\text{V}$ ,  $BAT = 3.6\text{V}$ ,  $SCAP = 0\text{V}$ ,  $LDO\_IN = 0\text{V}$  unless otherwise specified.

SYMBOL	PARAMETER	CONDITIONS	MIN	TYP	MAX	UNITS	
$I_{SHUNT}$	Maximum Protective Shunt Current		25			mA	
	Internal Bridge Rectifier Loss ( $ V_{AC1} - V_{AC2}  - V_{IN}$ )	$I_{BRIDGE} = 10\mu\text{A}$ $I_{BRIDGE} = 50\text{mA}$	700 1400	800 1500	900 1600	mV mV	
	Internal Bridge Rectifier Reverse Leakage Current	$V_{REVERSE} = 18\text{V}$			20	nA	
	Internal Bridge Rectifier Reverse Breakdown Voltage	$I_{REVERSE} = 1\mu\text{A}$	$V_{SHUNT}$	30		V	
$V_{OUT}$	Regulated Buck/Buck-Boost Output Voltage	1.8V Output Selected Sleep Threshold Wakeup Threshold	● ●	TBD	1.806 1.794	TBD	V V
		2.5V Output Selected Sleep Threshold Wakeup Threshold	● ●	TBD	2.508 2.492	TBD	V V
		2.8V Output Selected Sleep Threshold Wakeup Threshold	● ●	TBD	2.809 2.791	TBD	V V
		3.0V Output Selected Sleep Threshold Wakeup Threshold	● ●	TBD	3.010 2.990	TBD	V V
		3.3V Output Selected Sleep Threshold Wakeup Threshold	● ●	TBD	3.311 3.289	TBD	V V
		3.6V Output Selected Sleep Threshold Wakeup Threshold	● ●	TBD	3.612 3.588	TBD	V V
		4.5V Output Selected Sleep Threshold Wakeup Threshold	● ●	TBD	4.515 4.485	TBD	V V
		5.0V Output Selected Sleep Threshold Wakeup Threshold	● ●	TBD	5.017 4.983	TBD	V V
$I_{PEAK\_BUCK}$	Buck Peak Switch Current		200	250	350	mA	
$I_{BUCK}$	Available Buck Output Current	●	100			mA	
$I_{PEAK\_BB}$	Buck-Boost Peak Switch Current	250mA Target Selected			250	350	mA
		150mA Target Selected			150	TBD	mA
		100mA Target Selected			100	TBD	mA
		50mA Target Selected			50	TBD	mA
		25mA Target Selected			25	TBD	mA
		15mA Target Selected			15	TBD	mA
		10mA Target Selected			10	TBD	mA
		5mA Target Selected			5	TBD	mA
$I_{BB}$	Available Buck-Boost Current	$I_{PEAK\_BB} = 250\text{mA}$ , $BAT = 1.8\text{V}$ , $V_{OUT} = 3.3\text{V}$	●	50		mA	
$R_{P\_BUCK}$	Buck PMOS Switch On-Resistance			1.1		$\Omega$	
$R_{N\_BUCK}$	Buck NMOS Switch On-Resistance			1.3		$\Omega$	
$R_{P\_BB}$	Buck-Boost PMOS Switch On-Resistance	Input and Output Switches		0.5		$\Omega$	
$R_{N\_BB}$	Buck-Boost NMOS Switch On-Resistance	Input and Output Switches		0.5		$\Omega$	
$R_{P\_LDO}$	LDO PMOS Switch On-Resistance	$LDO\_IN = 2.5\text{V}$ , $I_{LDO\_OUT} = 50\text{mA}$		7		$\Omega$	

3330p

## ELECTRICAL CHARACTERISTICS

The ● denotes the specifications which apply over the specified operating junction temperature range, otherwise specifications are at  $T_A = 25^\circ\text{C}$  (Note 2).  $V_{IN} = 5\text{V}$ ,  $BAT = 3.6\text{V}$ ,  $SCAP = 0\text{V}$ ,  $LDO\_IN = 0\text{V}$  unless otherwise specified.

SYMBOL	PARAMETER	CONDITIONS	MIN	TYP	MAX	UNITS
$I_{LEAK(P)}$	PMOS Switch Leakage	Buck/Buck-Boost Regulators	-20		20	nA
$I_{LEAK(N)}$	NMOS Switch Leakage	Buck/Buck-Boost Regulators	-20		20	nA
	Maximum Buck Duty Cycle	Buck/Buck-Boost Regulators ●	100			%
	PGVOUT Threshold	As a Percentage of $V_{OUT}$ Target ●	90	92.5	95	%
	PGLDO Threshold	As a Percentage of LDO_OUT Target ●	90	92.5	95	%
$V_{IH}$	Digital Input High Voltage	Pins LDO_EN, OUT[2:0], LDO[2:0], IPK[2:0], UV[3:0] ●	1.2			V
$V_{IL}$	Digital Input Low Voltage	Pins LDO_EN, OUT[2:0], LDO[2:0], IPK[2:0], UV[3:0] ●			0.4	V
$I_{IH}$	Digital Input High Current	Pins LDO_EN, OUT[2:0], LDO[2:0], IPK[2:0], UV[3:0]		0	10	nA
$I_{IL}$	Digital Input Low Current	Pins LDO_EN, OUT[2:0], LDO[2:0], IPK[2:0], UV[3:0]		0	10	nA
$V_{OH}$	PGVOUT, PGLDO, EH_ON Output High Voltage	$V_{IN3} = 5\text{V}$ , $10\mu\text{A}$ Out of Pin ●	4.6			V
$V_{OL}$	PGVOUT, PGLDO, EH_ON Output Low Voltage	$V_{IN3} = 5\text{V}$ , $10\mu\text{A}$ into Pin ●			0.4	V

**Note 1:** Stresses beyond those listed under Absolute Maximum Ratings may cause permanent damage to the device. Exposure to any Absolute Maximum Rating condition for extended periods may affect device reliability and lifetime.

**Note 2:** The LTC3330E is tested under pulsed load conditions such that  $T_J \approx T_A$ . The LTC3330E is guaranteed to meet specifications from  $0^\circ\text{C}$  to  $85^\circ\text{C}$ . The LTC3330I is guaranteed over the  $-40^\circ\text{C}$  to  $125^\circ\text{C}$  operating junction temperature range. Note that the maximum ambient temperature

consistent with these specifications is determined by specific operating conditions in conjunction with board layout, the rated package thermal impedance and other environmental factors.

**Note 3:**  $T_J$  is calculated from the ambient  $T_A$  and power dissipation PD according to the following formula:  $T_J = T_A + (P_D \cdot \theta_{JA})$ .

**Note 4:** Dynamic supply current is higher due to gate charge being delivered at the switching frequency.

## TYPICAL PERFORMANCE CHARACTERISTICS

$I_{VIN}$  in UVLO vs  $V_{IN}$

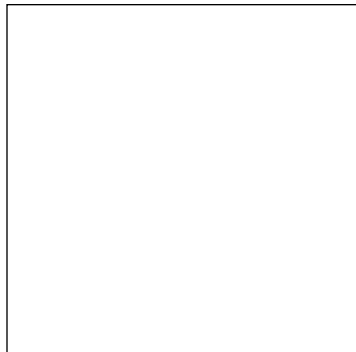

$I_{VIN}$  in Sleep vs  $V_{IN}$

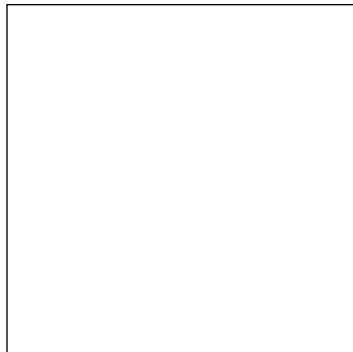

$I_{BAT}$  in Sleep vs BAT

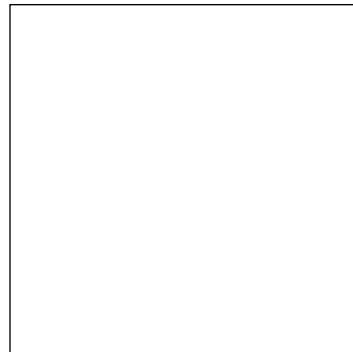

UVLO Rising vs Temperature

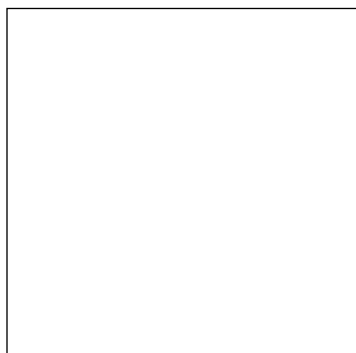

UVLO Falling vs Temperature

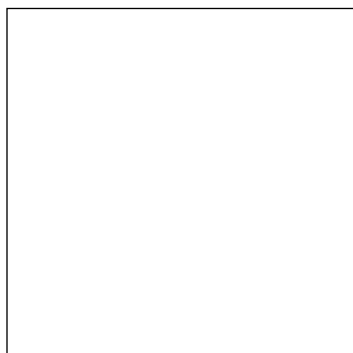

$V_{SHUNT}$  vs Temperature

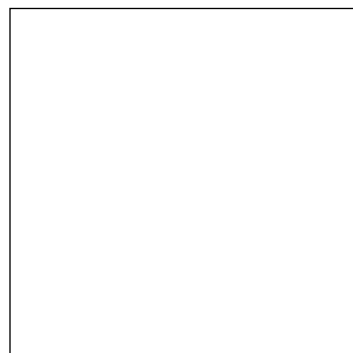

Total Bridge Rectifier Drop vs Bridge Current

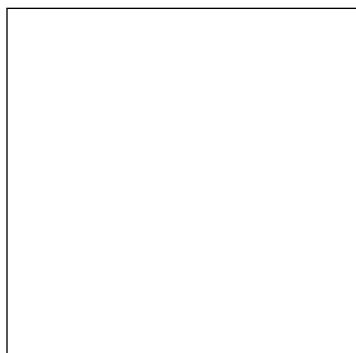

Bridge Leakage vs Temperature

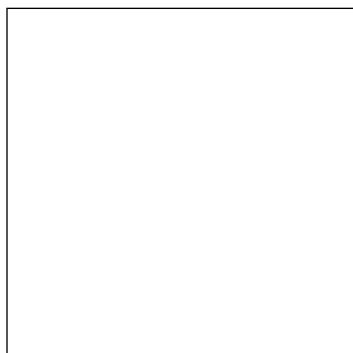

Bridge Frequency Response

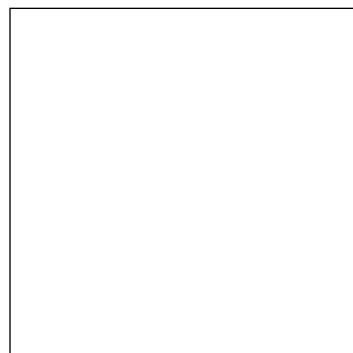

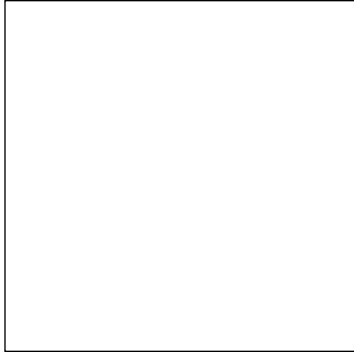
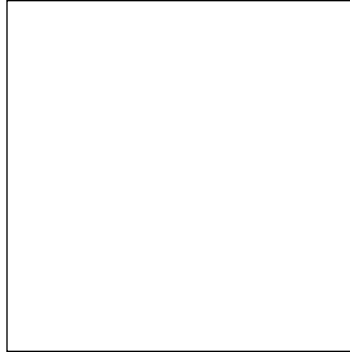
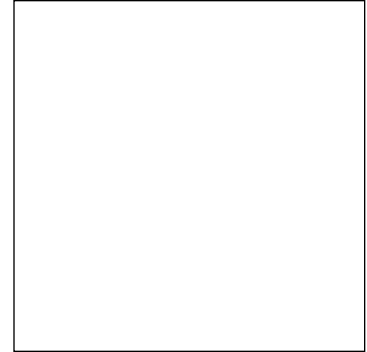
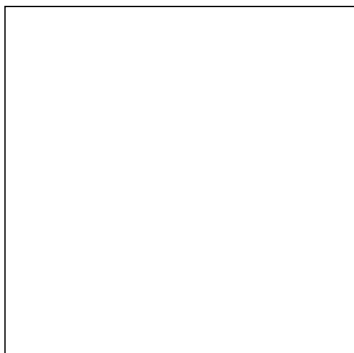
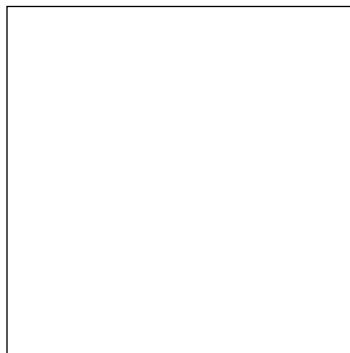
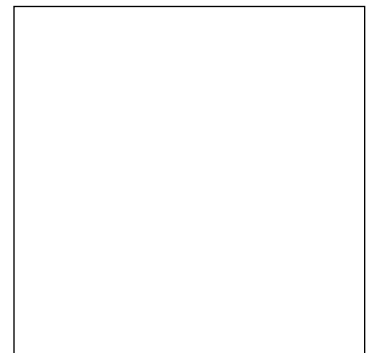
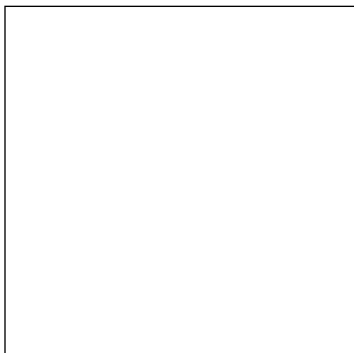
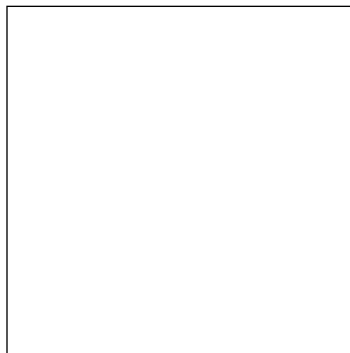
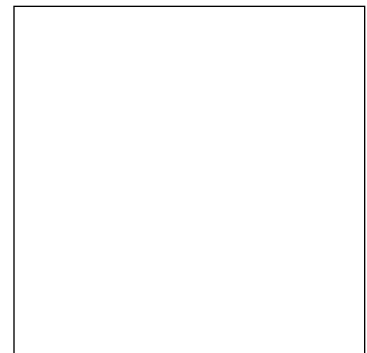
**TYPICAL PERFORMANCE CHARACTERISTICS** **$V_{OUT}$  vs Temperature (1.8V, 2.5V, 2.8V, 3.0V)** **$V_{OUT}$  vs Temperature (3.3V, 3.6V, 4.5V, 5.0V)** **$I_{VOUT}$  vs Temperature** **$V_{OUT}$  Load Regulation Buck/Buck-Boost** **$V_{OUT}$  Line Regulation Buck/Buck-Boost** **$I_{PEAK-BUCK}$  vs Temperature** **$R_{DS(ON)}$  of Buck PMOS/NMOS vs Temperature** **$I_{PEAK\_BB}$  vs Temperature (250mA, 150mA, 100mA, 50mA)** **$I_{PEAK\_BB}$  vs Temperature (25mA, 15mA, 10mA, 5mA)**

## TYPICAL PERFORMANCE CHARACTERISTICS

**$R_{DS(ON)}$  of Buck-Boost PMOS/  
NMOS vs Temperature**

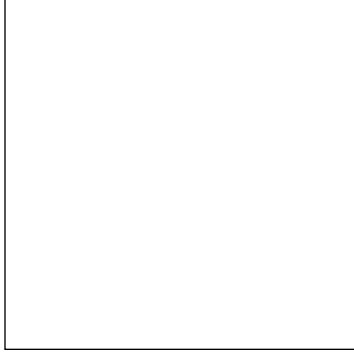

**Buck Switching Waveforms**

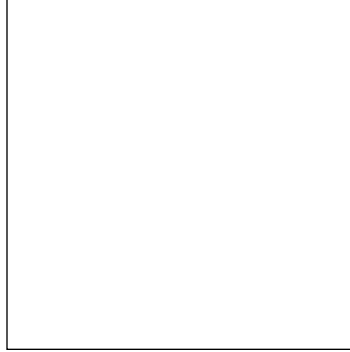

**Buck-Boost Switching Waveforms**

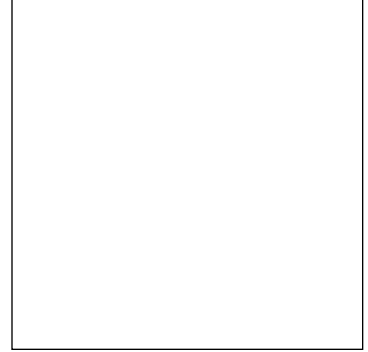

**Buck Efficiency vs  $I_{LOAD}$**

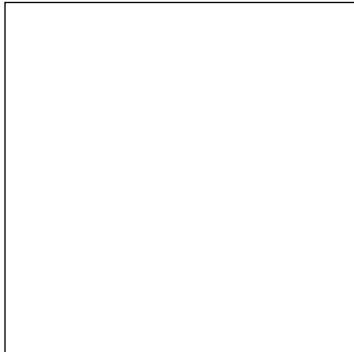

**Buck-Boost Efficiency vs  $I_{LOAD}$**

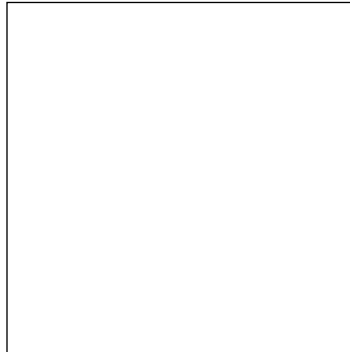

**Prioritizer Buck-Boost to Buck  
Transition**

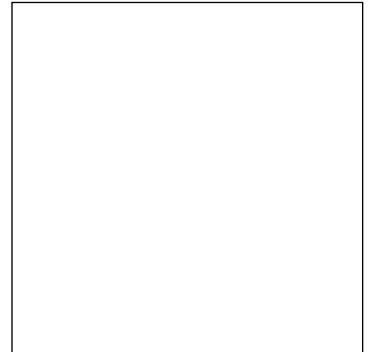

**Prioritizer Buck to Buck-Boost  
Transition**

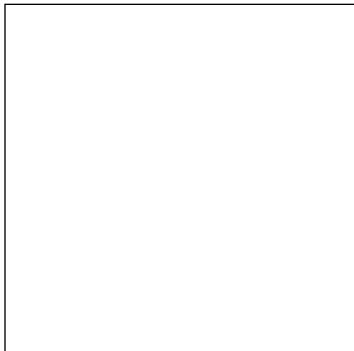

**$I_{SCAP}$  vs SCAP**

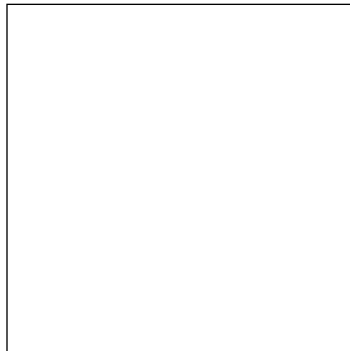

**Supercapacitor Balancer Source/  
Sink Current**

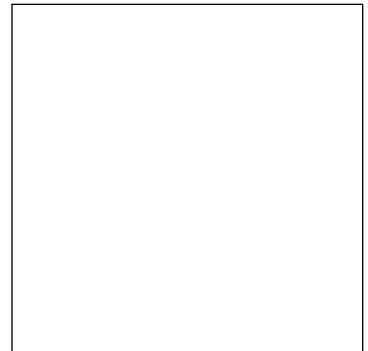



# TYPICAL PERFORMANCE CHARACTERISTICS

$I_{LDO\_IN}$  vs LDO\_IN

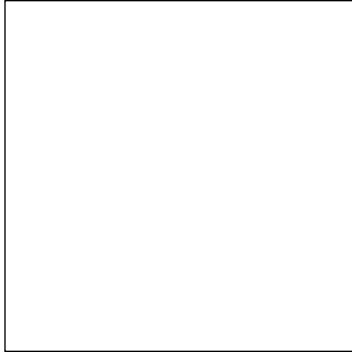

LDO\_OUT vs Temperature

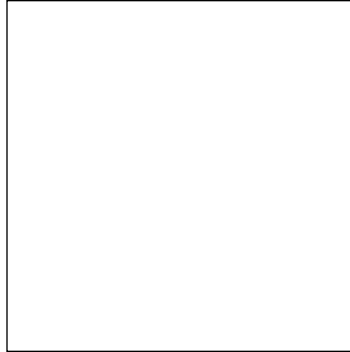

LDO Load Step

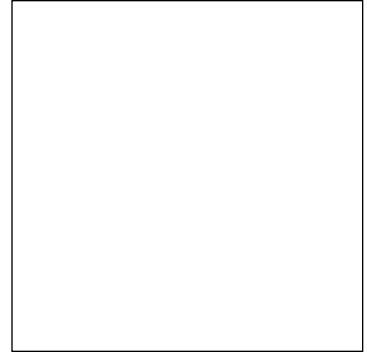

LDO Load Regulation

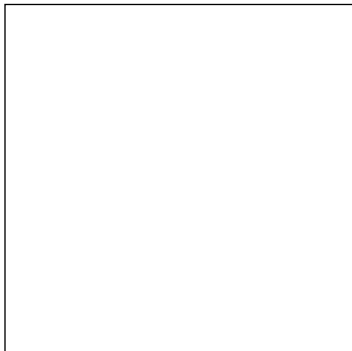

LDO Line Regulation

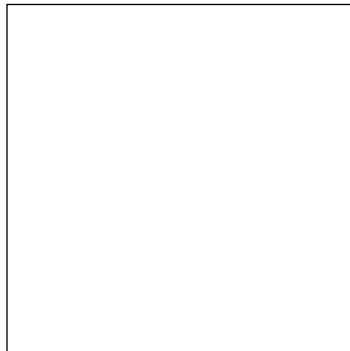

LDO Current Limit

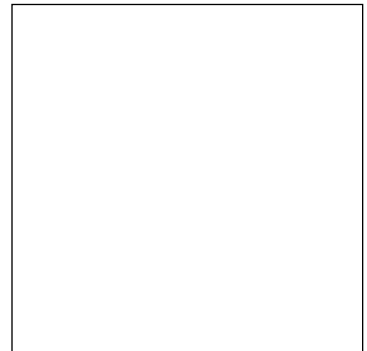

$R_{DS(ON)}$  of LDO PMOS

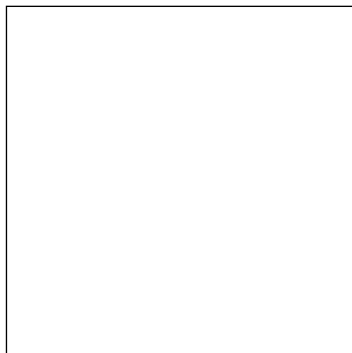

LDO Start-Up

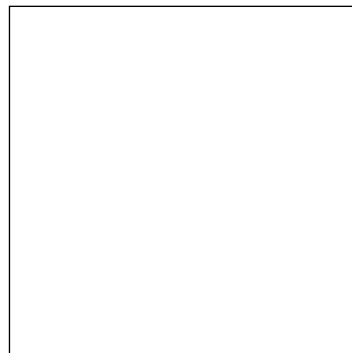

## PIN FUNCTIONS

**BAL (Pin 1):** Supercapacitor Balance Point. The common node of a stack of two supercapacitors is connected to BAL. A source/sink balancing current of up to 10mA is available. Tie BAL along with SCAP to GND to disable the balancer and its associated quiescent current.

**SCAP (Pin 2):** Supply and Sense Point for Supercapacitor Balancer. Tie the top of a 2-capacitor stack to SCAP and the middle of the stack to BAL to activate balancing. Tie SCAP along with BAL to GND to disable the balancer and its associated quiescent current.

**V<sub>IN2</sub> (Pin 3):** Internal Low Voltage Rail to Serve as Gate Drive for Buck NMOS Switch. Connect a 4.7 $\mu$ F (or larger) capacitor from V<sub>IN2</sub> to GND. This pin is not intended for use as an external system rail.

**UV3, UV2, UV1, UV0 (Pins 4, 5, 6, 7):** UVLO Select Bits for the Buck Switching Regulator. Tie high to V<sub>IN2</sub> or low to GND to select the desired UVLO rising and falling thresholds (see Table 4). Do not float.

**AC1 (Pin 8):** Input Connection for Piezoelectric Element or Other AC Source (used in conjunction with AC2 for differential AC inputs).

**AC2 (Pin 9):** Input Connection for Piezoelectric Element or Other AC Source (used in conjunction with AC1 for differential AC inputs).

**V<sub>IN</sub> (Pin 10):** Rectified Input Voltage. A capacitor on this pin serves as an energy reservoir and input supply for the buck regulator. The V<sub>IN</sub> voltage is internally clamped to a maximum of 20V (typical).

**CAP (Pin 11):** Internal Rail Referenced to V<sub>IN</sub> to Serve as Gate Drive for Buck PMOS Switch. Connect a 1 $\mu$ F (or larger) capacitor between CAP and V<sub>IN</sub>. This pin is not intended for use as an external system rail.

**SW (Pin 12):** Switch Node for the Buck Switching Regulator. Connect a 22 $\mu$ H or greater external inductor between this node and V<sub>OUT</sub>.

**V<sub>OUT</sub> (Pin 13):** Regulated Output Voltage Derived from the Buck or Buck-Boost Switching Regulator.

**SWB (Pin 14):** Switch Node for the Buck-Boost Switching Regulator. Connect an external inductor between this node and SWA of value per Table 3.

**SWA (Pin 15):** Switch Node for the Buck-Boost Switching Regulator. Connect an external inductor between this node and SWB of value per Table 3.

**BAT (Pin 16):** Input for Battery. BAT serves as the input to the buck-boost switching regulator.

**IPK0, IPK1, IPK2 (Pins 17, 18, 19):** IPEAK Select Bits for the Buck-Boost Switching Regulator. Tie high to V<sub>IN3</sub> or low to GND to select the desired IPEAK (see Table 3). Do not float.

**LDO\_OUT (Pin 20):** Regulated LDO Output. This output can be used as a quiet supply. One mode is provided to run the LDO as a current limited switch to alternately power up and power down circuitry without low power modes.

**LDO\_IN (Pin 21):** Input Voltage for the LDO regulator.

**LD02, LD01, LD00 (Pins 22, 23, 24):** LDO Voltage Select Bits. Tie high to LDO\_IN or low to GND to select the desired LDO\_OUT voltage (see Table 2). Do not float.

**LDO\_EN (Pin 25):** LDO Enable Input. Active high input with logic levels referenced to LDO\_IN. Do not float.

**V<sub>IN3</sub> (Pin 26):** Internal Low Voltage Rail Used by the Prioritizer. Connect a 1 $\mu$ F (or larger) capacitor from V<sub>IN3</sub> to GND. This pin is not intended for use as an external system rail.

**PGLDO (Pin 27):** Power Good Output for LDO\_OUT. Logic level output referenced to an internal maximum rail (see Operation). PGLDO transitioning high indicates 92.5% (typical) regulation has been reached on LDO\_OUT. PGLDO remains high until LDO\_OUT falls to 90.0% (typical) of the programmed regulation point.

**PGVOUT (Pin 28):** Power Good Output for V<sub>OUT</sub>. Logic level output referenced to an internal maximum rail (see Operation). PGVOUT transitioning high indicates regulation has been reached on V<sub>OUT</sub> (V<sub>OUT</sub> = Sleep Rising). PGVOUT remains high until V<sub>OUT</sub> falls to 92.5% (typical) of the programmed regulation point.

**BAT\_ON (Pin 29):** Switcher Status. Logic level output referenced to V<sub>IN3</sub>. EH\_ON is high when the buck switching regulator is in use. It is pulled low when buck-boost switching regulator is in use.

## PIN FUNCTIONS

**OUT0, OUT1, OUT2 (Pins 30, 31, 32):**  $V_{OUT}$  Voltage Select Bits. Tie high to  $V_{IN3}$  or low to GND to select the desired  $V_{OUT}$  (see Table 1). Do not float.

**GND (Exposed Pad Pin 11):** Ground. The exposed pad must be connected to a continuous ground plane on the second layer of the printed circuit board by several vias directly under the LTC3330.

## BLOCK DIAGRAM

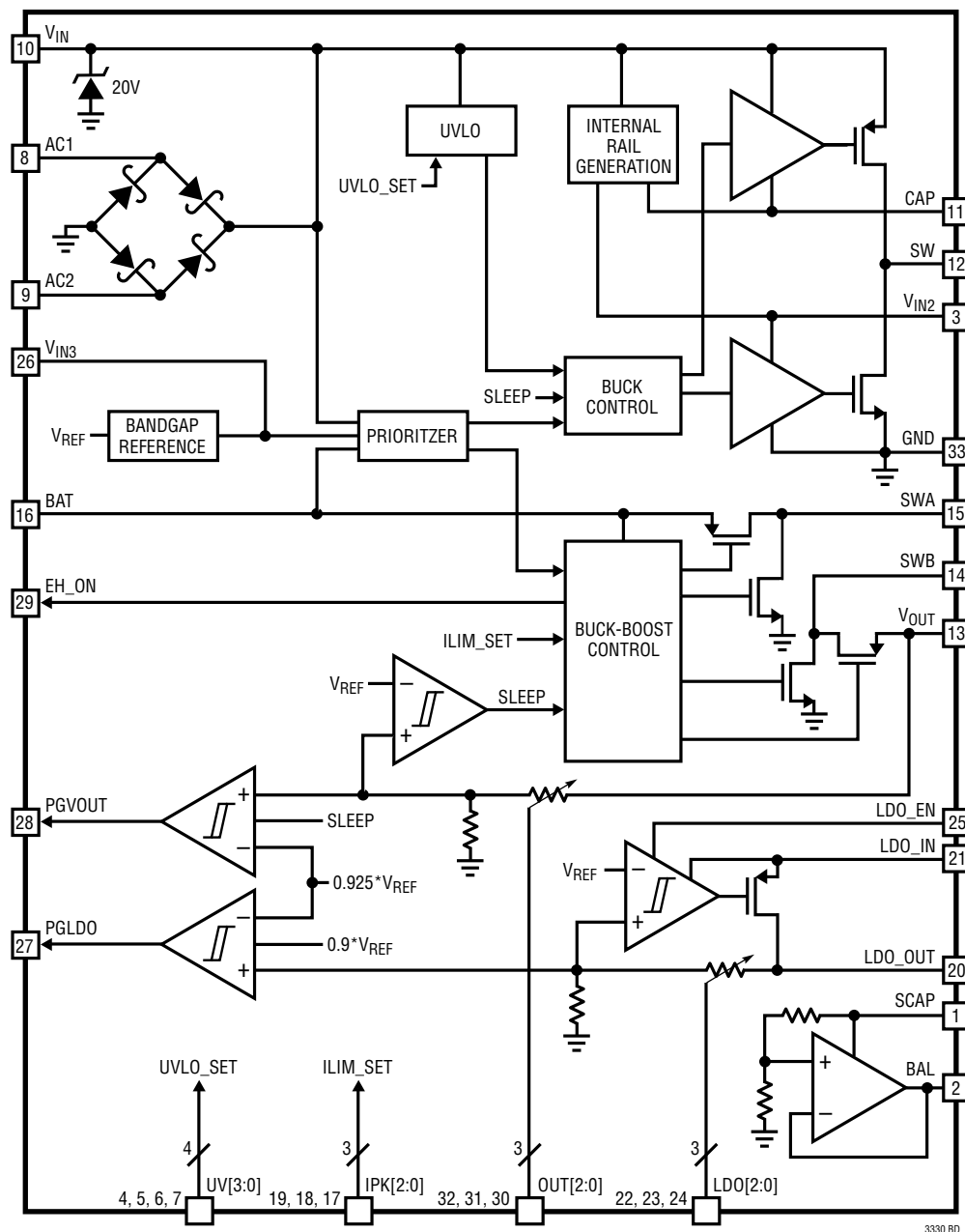

3330 BD

## OPERATION

### Modes of Operation

The following four tables detail all programmable settings on the LTC3330.

**Table 1. Output Voltage Selection**

OUT2	OUT1	OUT0	V <sub>OUT</sub>
0	0	0	1.8V
0	0	1	2.5V
0	1	0	2.8V
0	1	1	3.0V
1	0	0	3.3V
1	0	1	3.6V
1	1	0	4.5V
1	1	1	5.0V

**Table 2. LDO Voltage Selection**

LD02	LD01	LD00	LDO_OUT
0	0	0	1.2V
0	0	1	1.5V
0	1	0	1.8V
0	1	1	2.0V
1	0	0	2.5V
1	0	1	3.0V
1	1	0	3.3V
1	1	1	= LDO_IN

**Table 3. I<sub>LIM</sub> Selection**

IPK <sub>2</sub>	IPK <sub>1</sub>	IPK <sub>0</sub>	I <sub>LIM</sub>	L <sub>MIN</sub>
0	0	0	5mA	1100μH
0	0	1	10mA	560μH
0	1	0	15mA	360μH
0	1	1	25mA	220μH
1	0	0	50mA	110μH
1	0	1	100mA	56μH
1	1	0	150mA	36μH
1	1	1	250mA	22μH

**Table 4. V<sub>IN</sub> UVLO Threshold Selection**

UV3	UV2	UV1	UV0	UVLO RISING	UVLO FALLING
0	0	0	0	4V	3V
0	0	0	1	5V	4V
0	0	1	0	6V	5V
0	0	1	1	7V	6V
0	1	0	0	8V	7V
0	1	0	1	8V	5V
0	1	1	0	10V	9V
0	1	1	1	10V	5V
1	0	0	0	12V	11V
1	0	0	1	12V	5V
1	0	1	0	14V	13V
1	0	1	1	14V	5V
1	1	0	0	16V	15V
1	1	0	1	16V	5V
1	1	1	0	18V	17V
1	1	1	1	18V	5V

## OPERATION

### OVERVIEW

The LTC3330 combines a buck switching regulator and a buck-boost switching regulator to produce an energy harvesting solution with battery backup. The converters are controlled by a prioritizer that selects which converter to use based on the availability of a battery and/or harvestable energy. If harvested energy is available the buck regulator is active and the buck-boost is OFF. With an optional LDO and supercapacitor balancer and an array of different configurations the LTC3330 suits many applications.

### BUCK CONVERTER

The synchronous buck converter is an ultralow quiescent current power supply tailored to energy harvesting applications. It is designed to interface directly to a piezoelectric or alternative A/C power source, rectify the input voltage, and store harvested energy on an external capacitor while maintaining a regulated output voltage. It can also bleed off any excess input power via an internal shunt regulator.

### INTERNAL BRIDGE RECTIFIER

An internal full-wave bridge rectifier accessible via the differential AC1 and AC2 inputs rectifies AC sources such as those from a piezoelectric element. The rectified output is stored on a capacitor at the  $V_{IN}$  pin and can be used as an energy reservoir for the buck converter. The bridge rectifier has a total drop of about 800mV with typical piezo-generated currents ( $\sim 10\mu\text{A}$ ), but is capable of carrying up to 50mA. Either side of the bridge can be operated independently as single-ended AC or DC inputs.

### UNDERVOLTAGE LOCKOUT

When the voltage on  $V_{IN}$  rises above the UVLO rising threshold the buck converter is enabled and charge is transferred from the input capacitor to the output capacitor. When the input capacitor voltage is depleted below the UVLO falling threshold the buck converter is disabled. These thresholds can be set according to Table 4 which offers UVLO rising thresholds from 4V to 18V with large or small hysteresis windows (see Table 4). Extremely low

quiescent current (450nA typical) in UVLO allows energy to accumulate on the input capacitor in situations where energy must be harvested from low power sources.

### INTERNAL RAIL GENERATION

Two internal rails, CAP and  $V_{IN2}$ , are generated from  $V_{IN}$  and are used to drive the high side PMOS and low side NMOS of the buck converter, respectively. Additionally the  $V_{IN2}$  rail serves as logic high for the UVLO threshold select bits UV[3:0]. The  $V_{IN2}$  rail is regulated at 4.8V above GND while the CAP rail is regulated at 4.8V below  $V_{IN}$ . These are not intended to be used as external rails. Bypass capacitors are connected to the CAP and  $V_{IN2}$  pins to serve as energy reservoirs for driving the buck switches. When  $V_{IN}$  is below 4.8V,  $V_{IN2}$  is equal to  $V_{IN}$  and CAP is held at GND. Figure 1 shows the ideal  $V_{IN}$ ,  $V_{IN2}$  and CAP relationship.

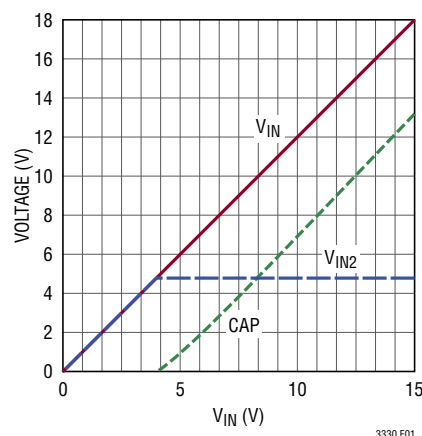

Figure 1. Ideal  $V_{IN}$ ,  $V_{IN2}$  and CAP Relationship

### BUCK OPERATION

The buck regulator uses a hysteretic voltage algorithm to control the output through internal feedback from the  $V_{OUT}$  sense pin. The buck converter charges an output capacitor through an inductor to a value slightly higher than the regulation point. It does this by ramping the inductor current up to 260mA through an internal PMOS switch and then ramping it down to 0mA through an internal NMOS switch. This efficiently delivers energy to the output capacitor. The ramp rate is determined by  $V_{IN}$ ,

## OPERATION

$V_{OUT}$ , and the inductor value. When the buck brings the output voltage into regulation the converter enters a low quiescent current sleep state that monitors the output voltage with a sleep comparator. During this operating mode load current is provided by the output capacitor. When the output voltage falls below the regulation point the buck regulator wakes up and the cycle repeats. This hysteretic method of providing a regulated output reduces losses associated with FET switching and maintains an output at light loads. The buck delivers a minimum of 100mA of average load current when it is switching.  $V_{OUT}$  can be set from 1.8V to 5V via  $OUT[2:0]$  (see Table 1).

When the sleep comparator signals that the output has reached the sleep threshold the buck converter may be in the middle of a cycle with current still flowing through the inductor. Normally both synchronous switches would turn off and the current in the inductor would freewheel to zero through the NMOS body diode, but the NMOS switch is kept on to prevent the conduction loss that would occur in the diode if the NMOS were off. If the PMOS is on when the sleep comparator trips the NMOS will turn on immediately in order to ramp down the current. If the NMOS is on it will be kept on until the current reaches zero.

Though the quiescent current when the buck is switching is much greater than the sleep quiescent current, it is still a small percentage of the average inductor current which results in high efficiency over most load conditions. The buck operates only when sufficient energy has been accumulated in the input capacitor and the length of time the converter needs to transfer energy to the output is much less than the time it takes to accumulate energy. Thus, the buck operating quiescent current is averaged over a long period of time so that the total average quiescent current is low. This feature accommodates sources that harvest small amounts of ambient energy.

### BUCK-BOOST CONVERTER

The buck-boost uses the same hysteretic voltage algorithm as the buck to control the output,  $V_{OUT}$ , with the same sleep comparator. The buck-boost has three modes of operation: buck, buck-boost, and boost. An internal mode

comparator determines the mode of operation based on  $BAT$  and  $V_{OUT}$ . Figure 2 shows the four internal switches of the buck-boost converter. In each mode the inductor current is ramped up to  $I_{PEAK}$ . This  $I_{PEAK}$  value is programmable via  $IPK[2:0]$  and ranges from 5mA to 250mA (see Table 3).

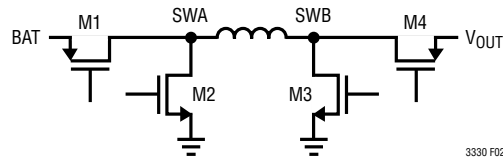

Figure 2: Buck-Boost Power Switches

In BUCK mode M4 is always on and M3 is always off. The inductor current is ramped up through M1 to  $I_{PEAK}$  and down to 0mA through M2. In boost mode M1 is always on and M2 is always off. The inductor current is ramped up to  $I_{PEAK}$  when M3 is on and is ramped to 0mA when M4 is on as  $V_{OUT}$  is greater than  $BAT$  in boost mode. Buck-boost mode is very similar to boost mode in that M1 is always on and M2 is always off. If  $BAT$  is less than  $V_{OUT}$  the inductor current is ramped up to  $I_{PEAK}$  through M3. When M4 turns on the current in the inductor will start to ramp down. However, because  $BAT$  is close to  $V_{OUT}$  and M1 and M4 have finite on-resistance the current ramp will exhibit a slow exponential decay, lowering the average current delivered to  $V_{OUT}$ . For this reason the lower current threshold is set to  $I_{PEAK}/2$  in buck-boost mode to maintain high average current to the load. If  $BAT$  is greater than  $V_{OUT}$  in buck-boost mode the inductor current still ramps up to  $I_{PEAK}$  and down to  $I_{PEAK}/2$ . It can still ramp down if  $BAT$  is greater than  $V_{OUT}$  because the final value of the current in the inductor is  $(V_{IN} - V_{OUT}) / (R_{ON1} + R_{ON4})$ . If  $BAT$  is exactly  $I_{PEAK}/2 \cdot (R_{ON1} + R_{ON4})$  above  $V_{OUT}$  the inductor current will not reach the  $I_{PEAK}/2$  threshold and switches M1 and M4 will stay on all the time. For higher  $BAT$  voltages the mode comparator will switch the converter to buck mode. M1 and M4 will remain on for  $BAT$  voltages up to  $V_{OUT} + I_{PEAK} \cdot (R_{ON1} + R_{ON4})$ . At

## OPERATION

this point the current in the inductor is equal to IPEAK and the IPEAK comparator will trip turning off M1 and turning on M2 causing the inductor current to ramp down to IZERO, completing the transition from buck-boost mode to buck mode.

### V<sub>OUT</sub> Power Good

A power good comparator is provided for the V<sub>OUT</sub> output. It transitions high the first time the LTC3330 goes to sleep, indicating that V<sub>OUT</sub> has reached regulation. It transitions low when V<sub>OUT</sub> falls to 92.5% (typical) of its value at regulation. The PGVOUT output is referenced to an internal rail that is generated to be the highest of V<sub>IN2</sub>, BAT, and V<sub>OUT</sub> less a Schottky diode drop.

### Prioritizer

The input prioritizer on the LTC3330 decides whether to use the energy harvesting input or the battery input to power V<sub>OUT</sub>. If a battery is powering the buck-boost converter and harvested energy causes a UVLO rising transition on V<sub>IN</sub>, the prioritizer will shut off the buck-boost and turn on the buck, orchestrating a smooth transition that maintains regulation of V<sub>OUT</sub>. When harvestable energy disappears, the prioritizer will first poll the battery voltage. If the battery voltage is above 1.8V the prioritizer will switch back to the buck-boost while maintaining regulation. If the battery voltage is below 1.8V the buck-boost is not enabled and V<sub>OUT</sub> cannot be supported until harvestable energy is again available. If either BAT or V<sub>IN</sub> is grounded, the prioritizer allows the other input to run if its input is high enough for operation.

When the prioritizer selects the V<sub>IN</sub> input the current on the BAT input drops to zero. However, if the voltage on BAT is higher than V<sub>IN2</sub>, 150nA (typical) will appear as quiescent current on BAT due to internal level shifting. This only affects a small range of battery voltages and UVLO settings.

A digital output, EH\_ON, is low when the prioritizer has selected the BAT input and is high when the prioritizer has selected the V<sub>IN</sub> input. The EH\_ON output is referenced to V<sub>IN3</sub>.

### Low Drop Out Regulator

An integrated low drop out regulator (LDO) is available with its own input, LDO\_IN. It will regulate LDO\_OUT to seven different output voltages based on the LDO[2:0] pins. An eighth mode is provided to turn the LDO into a current-limited switch in which the PMOS is always on. LDO\_EN enables the LDO when high and when low eliminates all quiescent current on LDO\_IN. The LDO is designed to provide 50mA over a range of LDO\_IN and LDO\_OUT combinations. A current limit set above 50mA is available to dial back the current if the output is grounded or the load demands more than 50mA. The LDO also features a 1ms soft-start for smooth output start-up.

A power good signal on the PGLDO pin indicates when the voltage at LDO\_OUT rises above 92.5% (typical) of its final value, or after tripped, when the LDO\_OUT falls below 90.0% of that value. The PGLDO output is referenced to an internal rail that is generated to be the highest of V<sub>IN2</sub>, BAT, and V<sub>OUT</sub> less a Schottky diode drop.

### Supercapacitor

An integrated supercapacitor balancer with 165nA of quiescent current is available to balance a stack of two supercapacitors. Typically the input, SCAP, will tie to V<sub>OUT</sub> to allow for increased energy storage at V<sub>OUT</sub> with supercapacitors. The BAL pin is tied to the middle of the stack and can source and sink 10mA to regulate the BAL pin's voltage to half that of the SCAP pin's voltage. To disable the balancer and its associated quiescent current the SCAP and BAL pins can be tied to ground.

## TYPICAL APPLICATIONS



## TYPICAL APPLICATIONS

## TYPICAL APPLICATIONS

# PACKAGE DESCRIPTION

Please refer to <http://www.linear.com/designtools/packaging/> for the most recent package drawings.

**UH Package**  
**32-Lead Plastic QFN (5mm × 5mm)**  
 (Reference LTC DWG # 05-08-1693 Rev D)

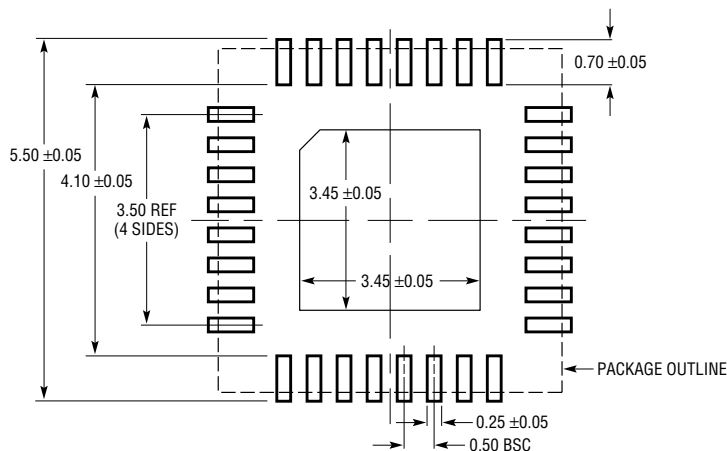

RECOMMENDED SOLDER PAD LAYOUT  
 APPLY SOLDER MASK TO AREAS THAT ARE NOT SOLDERED

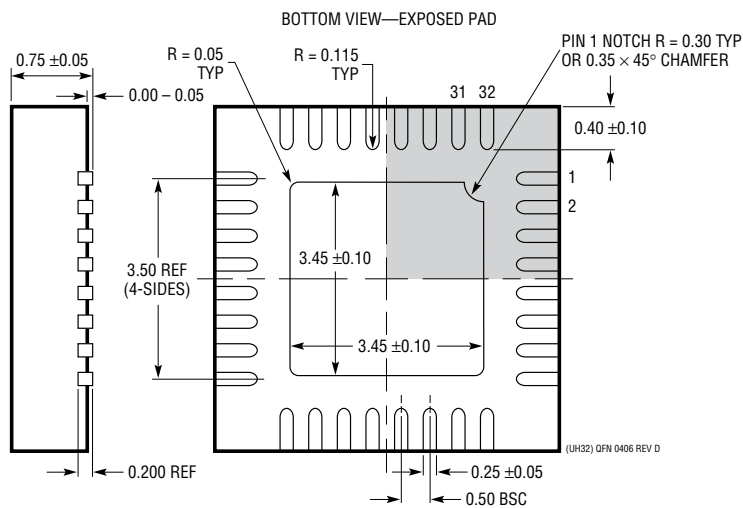
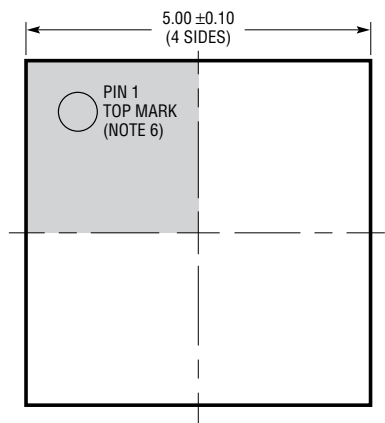

- NOTE:
1. DRAWING PROPOSED TO BE A JEDEC PACKAGE OUTLINE M0-220 VARIATION WHHD-(X) (TO BE APPROVED)
  2. DRAWING NOT TO SCALE
  3. ALL DIMENSIONS ARE IN MILLIMETERS
  4. DIMENSIONS OF EXPOSED PAD ON BOTTOM OF PACKAGE DO NOT INCLUDE MOLD FLASH. MOLD FLASH, IF PRESENT, SHALL NOT EXCEED 0.20mm ON ANY SIDE
  5. EXPOSED PAD SHALL BE SOLDER PLATED
  6. SHADED AREA IS ONLY A REFERENCE FOR PIN 1 LOCATION ON THE TOP AND BOTTOM OF PACKAGE

## TYPICAL APPLICATION

### UPS System for Wireless Mesh Networks with Output Supercapacitor Energy Storage

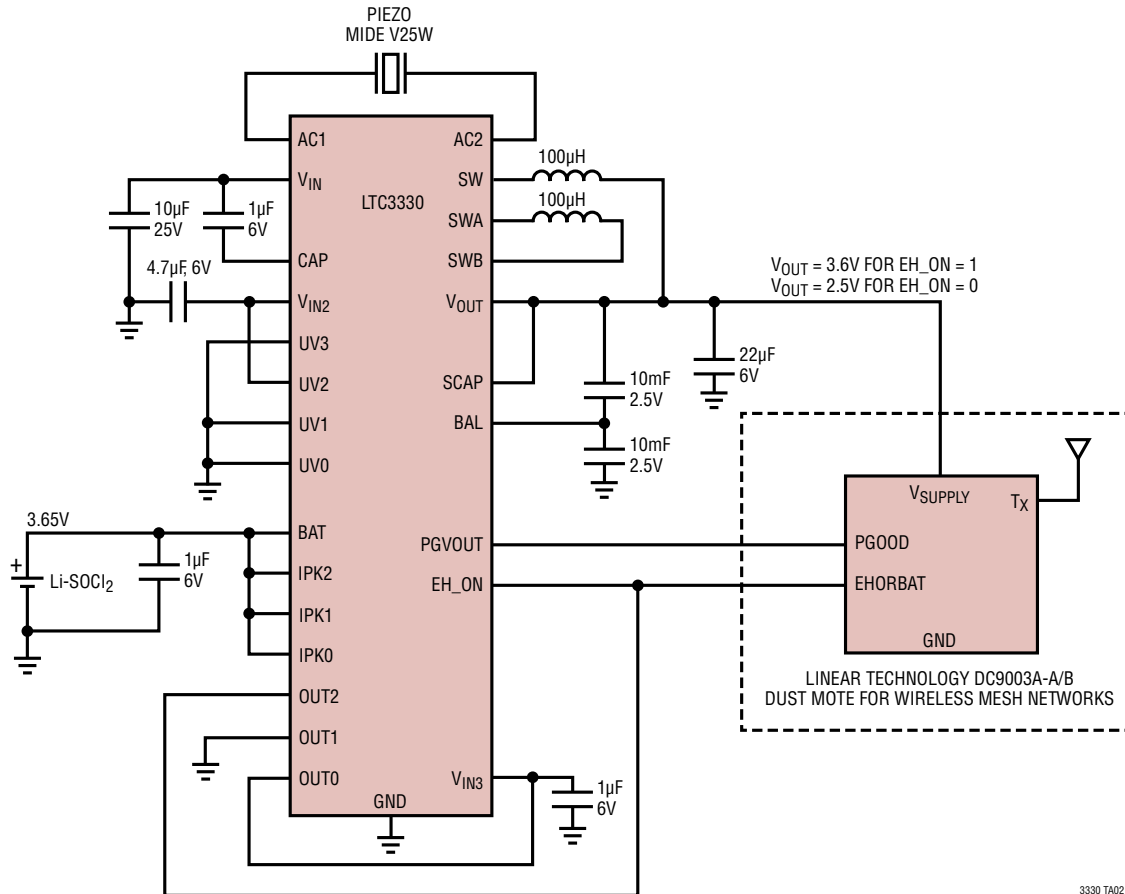

3330 TA02

## RELATED PARTS

PART NUMBER	DESCRIPTION	COMMENTS
<a href="#">LT1389</a>	Nanopower Precision Shunt Voltage Reference	800nA Operating Current, 1.25V/2.5V/4.096V
<a href="#">LTC1540</a>	Nanopower Comparator with Reference	0.3µA I <sub>Q</sub> , Drives 0.01µF, Adjustable Hysteresis, 2V to 11V Input Range
<a href="#">LT3009</a>	3µA I <sub>Q</sub> , 20mA Low Dropout Linear Regulator	Low 3µA I <sub>Q</sub> , 1.6V to 20V Range, 20mA Output Current
<a href="#">LTC3108</a>	Ultralow Voltage Step-Up Converter and Power Manager	Operates from 20mV inputs, LDO, Reserve Output, Power Good
<a href="#">LTC3109</a>	Auto-Polarity, Ultralow Voltage Step-Up Converter and Power Manager	Operates from 30mV Inputs, Auto-Polarity Architecture, LDO, Energy Storage Capability, Power Good
<a href="#">LTC3388-1/ LTC3388-3</a>	20V High Efficiency Nanopower Step-Down Regulator	860nA I <sub>Q</sub> in Sleep, 2.7V to 20V Input, V <sub>OUT</sub> : 1.2V to 5.0V, Enable and Standby Pins
<a href="#">LTC3588-1</a>	Piezoelectric Energy Harvesting Power Supply	<1µA I <sub>Q</sub> in Regulation, 2.7V to 20V Input Range, Integrated Bridge Rectifier
<a href="#">LTC3588-2</a>	Piezoelectric Energy Harvesting Power Supply	<1µA I <sub>Q</sub> in Regulation, UVLO Rising = 16V, UVLO Falling = 14V, V <sub>OUT</sub> = 3.45V, 4.1V, 4.5V, 5.0V
<a href="#">LTC4070</a>	Li-Ion/Polymer Shunt Battery Charger System	450nA I <sub>Q</sub> , 1% Float Voltage Accuracy, 50mA Shunt Current 4.0V/4.1V/4.2V
<a href="#">LTC4071</a>	Li-Ion/Polymer Shunt Battery Charger System with Low Battery Disconnect	550nA I <sub>Q</sub> , 1% Float Voltage Accuracy, 50mA Shunt Current 4.0V/4.1V/4.2V, 2.7V or 3.2V Battery Disconnect Levels

3330p